

Power Electronics Testings

LED Power Driver Test Solution

www.chromaate.com



Chroma

Turnkey Test & Automation Solution Provider

A Light Emitting Diode (LED), with low power consumption, compact size, long life duration and versatility, is ideal for lighting and illumination applications. LEDs have found its applications in LCD monitor/TV backlights, street lighting, automobile lighting, interior lighting, outdoors large screen displays, consumer electronics and various other applications.

LED power drivers are used to provide the power to the LEDs, and are usually designed as a constant current source due to the light emitting characteristics of the LEDs. Although LED power drivers' functions and characteristics differ from the general switch mode power supply (SMPS), the components used, the design topology and the testing requirements are very similar. Chroma is able to provide LED testing solution based on its thirty years of experience in providing power electronics testing solutions. These solutions include : programmable AC and DC Sources, high precision Power Meters, and LED Load Simulator specifically designed for LED power drivers. Chroma is also able to provide Automated Test Systems suitable for R&D, QA qualifications and mass production.



AC Power Source



Digital Power Meter



Input



LED Power Driver

Output



LED Load Simulator



Advance Programmable AC Power Sources

Model 61500 Series

Key Features

- ☑ Output : 500VA~4kVA/0~300VAC/424VDC
- ☑ AC, DC, AC+DC output mode
- ☑ Turn-on, turn-off phase angle control
- ☑ Programmable voltage and frequency slew rate
- ☑ Power line disturbance simulation : LIST, PULSE, STEP modes
- ☑ Distortion waveform editor : SYNTH and INTERHAR modes
- ☑ Measurement for RMS voltage, current, power, PF, VA, VAR, crest factor, peak and inrush current
- ☑ Standard AC source for IEC61000-3-2 testing
- ☑ IEC 61000-4-11, -4-13, -4-14, -4-28 regulation testing

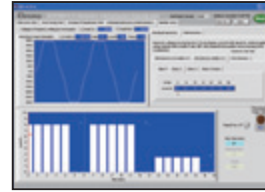

Voltage Harmonic & Interharmonics Test



Voltage DIP, Short, Variation Regulation Test

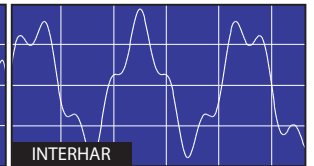
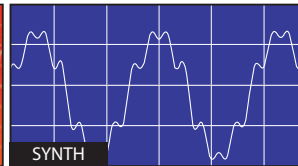
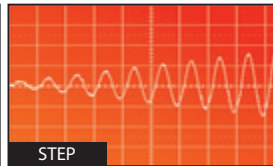
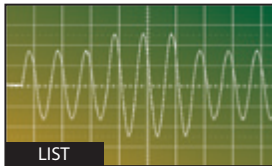
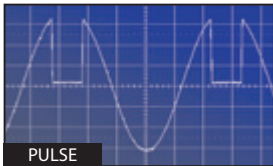

Model	61501	61502	61503	61504
Power	500VA	1000VA	1500VA	2000VA
Voltage	150V/300V/Auto	150V/300V/Auto	150V/300V/Auto	150V/300V/Auto
Max. Current	4A/2A (150V/300V)	8A/4A (150V/300V)	12A/6A (150V/300V)	16A/8A (150V/300V)
Frequency	DC, 15 ~ 1kHz	DC, 15 ~ 1kHz	DC, 15 ~ 1kHz	DC, 15 ~ 1kHz

Ideal for Energy Star & High Precision Power Measurement Digital Power Meters

Model 66200 Series

Key Features

- ☑ Voltage : Vrms, Vpeak+, Vpeak-
Current : Irms, Ipeak+, Ipeak-
Power : Watts, Power Factor, VA, VAR
- ☑ 5mA minimum current range & 0.1mW power resolution
- ☑ Meets ENERGY STAR/IEC 62301/ErP ecodesign/SPEC POWER measurement requirements
- ☑ Accumulated energy methods for unstable power measurement
- ☑ User-defined criteria provides automatic PASS/FAIL indications
- ☑ THD, Inrush current and energy measurements (Model 66202)
- ☑ Interface options : USB or USB+GPIB



66201/66202



66203/66204



66200 Softpanel



IEC 61000-3-2
Current Harmonic Test
(Pre-compliance)



Power Efficiency
Test Softpanel

Model	66202	66203/66204
Parameters	V, Vpk, I, Ipk, Is, W, VA, VAR, PF, CF_I, F, THD_V, THD_I, Energy	V, Vpk, I, Ipk, Is, W, VA, VAR, PF, CF_I, F, THD_V, THD_I, Energy
AC Voltage	150/300/500Vrms (CF = 1.6)	15V/30V/60V/150V/300V/600Vrms (CF=2)
AC Current	SHUNT H : 0.2/2/8/20Arms (CF=2@0.2/2/8A, CF = 4@ 20A) SHUNT L : 0.01/0.1/0.4/2Arms (CF=4)	5mA/20mA/50mA/200mA/500mA/2A/5A/20Arms (CF=4)
Power	47Hz ~ 63Hz : 0.1% of rdg + 0.1% of rng 15Hz ~ 1kHz : (0.1+ 0.2/PFXkHz)% of rdg + 0.18% of rng	DC, 47Hz to 63Hz: 0.1% RD + 0.1% RNG 10Hz to 1KHz: 0.1% RD + 0.18% RNG 1KHz to 10KHz: (0.1+0.1 x kHz)% RD + 0.18% RNG



LED Load Simulator

Model 63110A / 63113A / 63115A

Key Features

- ✓ Unique LED mode for LED power driver test
- ✓ Programmable LED dynamic resistance (R_d)
- ✓ Programmable internal resistance (R_r) for simulating LED ripple current (63110A)
- ✓ Fast response for PWM dimming test
- ✓ Up to eight channels in one mainframe
- ✓ 16-bit precision voltage and current measurement with dual-range
- ✓ Full Protection: OC, OP, OT protection and OV alarm



As a constant current source, the LED power driver has an output voltage range with a constant output current. LED power drivers are usually tested in one of the following ways;

1. With LEDs
2. Using resistors for loading
3. Using Electronic Loads in Constant Resistance (CR) mode, or Constant Voltage (CV) mode

However, all these testing methods each have their own disadvantages.

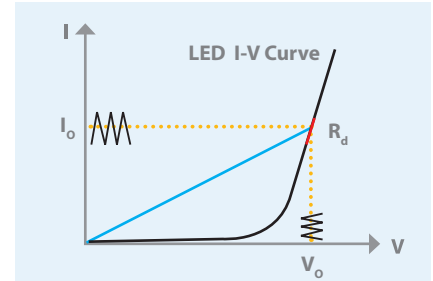
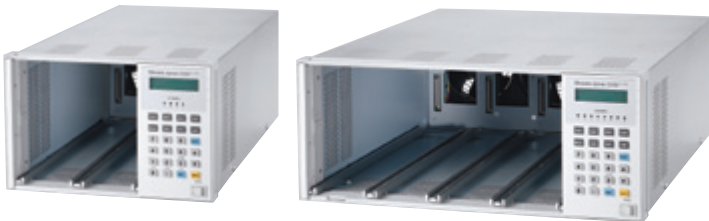

Figure 1 - LED V-I Characteristics

As shown on the I-V curve in figure 1, the LED has a forward voltage V_f and a operating resistance (R_d). When using a resistor as loading, the I-V curve of the resistor is not able to simulate the I-V curve of the LED as shown in blue on figure 1. This may cause the LED power driver to not start up due to the difference in I-V characteristic between the resistors and the LEDs. When using Electronic Loads, the CR and CV mode settings are set for when the LED is under stable operation and therefore, is unable to simulate turn on or PWM brightness control characteristics. This may cause the LED power driver to function improperly or trigger it's protection circuits. These testing requirements can be achieved when using a LEDs as a load; however, issues regarding the LED aging as well as different LED power drivers may require different types of LEDs or a number of LEDs. This makes it inconvenient for mass production testing.



Mainframe Model	6312A (2 slots)	6314A (4 slots)
Dimensions (H×W×D)	194×275×550 mm / 7.6×10.8×21.7 inch	194×439×550 mm / 7.6×17.3×21.7 inch
Weight	15 kg / 33.1 lbs	21.5 kg / 47.4 lbs

Chroma has created the industries first LED Load Simulator for simulating LED loading with our 63110A load model from 6310A series Electronic Loads. By setting the LED power driver's output voltage, and current, the Electronic Load can simulate the LED's loading characteristics. The LED's forward voltage and operating resistance can also be set to further adjust the loading current and ripple current to better simulate LED characteristics. The 63110A design also has increased bandwidth to allow for PWM dimming testing.

Figure 2 shows the current waveform from a LED load. Figure 3 shows the current waveform from 63110A's LED mode load function. From figures 2 and 3, the start up voltage and current of the LED power driver is very similar. Figure 4 shows the dimming current waveform of the LED. Figure 5 shows the dimming current waveform when using 63110A as a load.

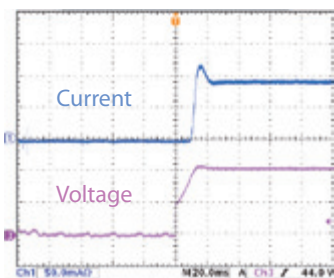

Figure 2 - LED loading

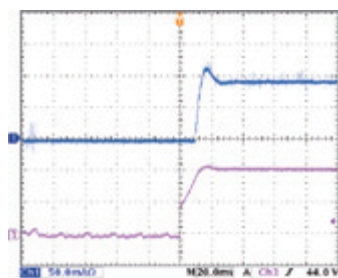

Figure 3 - 63110A LED mode loading

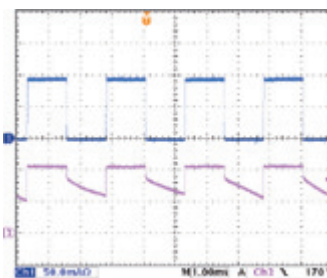

Figure 4 - LED dimming test

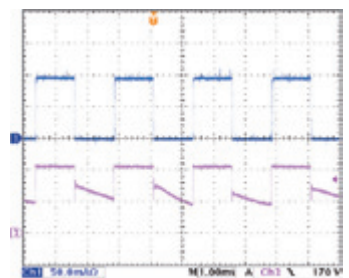

Figure 5 - 63110A dimming test

The internal resistance (R_r) can be adjusted to simulate the LED power driver output ripple current. The traditional E-load can not simulate the ripple current of LED shown as figure 6. Figure 7 shows the ripple current waveform from a LED load. Figure 8 shows the ripple current waveform from the 63110A LED mode load function. Figure 9 and 10 show the turn-on waveform of using a resistive load and an electronic load. It is obvious that these waveforms are very much different from the one with real LED (Figure 2). And it may cause the LED power drivers to fail as shown in figure 11, which causes it to go into protection. Figure 12 shows the I-V curve of different numbers of LEDs, and figure 13 shows the I-V curve of different characteristics of LEDs those can simulated by 63110A/63113A.

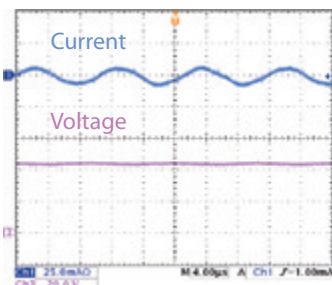

Figure 6 - Traditional E-load loading

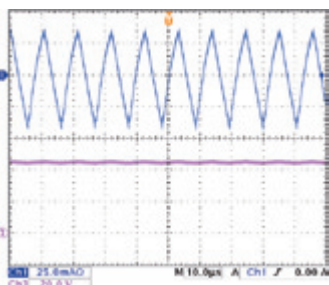

Figure 7 - LED loading

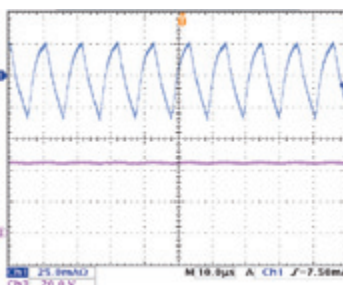

Figure 8 - 63110A loading

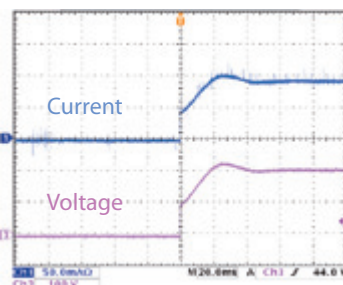

Figure 9 - Resistive loading

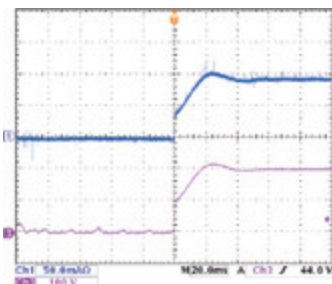

Figure 10 - CR mode loading

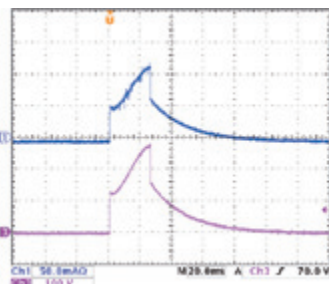

Figure 11 - Resistive loading (Fail)

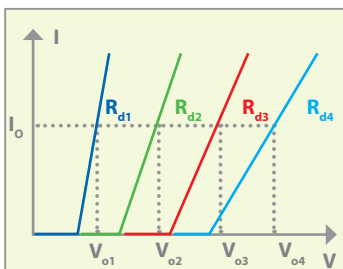

Figure 12 - Simulate different number of LEDs

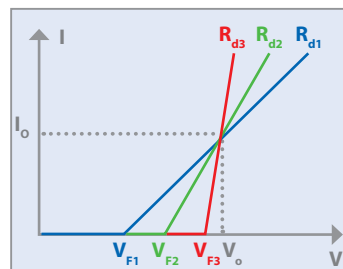

Figure 13 - Simulate different characteristic of LEDs

Model	63110A (100Wx2)		63113A		63115A	
Power	100W		300W		300W	
Current	0~0.6A	0~2A	0~5A	0~20A	0~5A	0~20A
Voltage*1	0~500V		0~300V		0~600V	
Min. Operating Voltage	6V@2A		4V@20A		4V@20A	
Constant Current Mode						
Range	0~0.6A	0~2A	0~5A	0~20A	0~5A	0~20A
Resolution	12μA	40μA	100μA	400μA	100μA	400μA
Accuracy	0.1%+0.1% F.S.		0.1%+0.1% F.S.	0.1%+0.2% F.S.	0.1%+0.1% F.S.	0.1%+0.2% F.S.
Constant Resistance Mode						
Range	CRL : 3 Ω~1k Ω (100W/100V) CRH : 10 Ω~10k Ω (100W/500V)		CRL @ CH : 0.2 Ω~200 Ω (300W/60V) CRL @ CL : 0.8 Ω~800 Ω (300W/60V) CRH @ CL : 4 Ω~4k Ω (300W/300V)		CRL @ CH : 0.2 Ω~200 Ω (300W/60V) CRL @ CL : 0.8 Ω~800 Ω (300W/60V) CRH @ CL : 8 Ω~8k Ω (300W/600V)	
Resolution*2	CRL : 62.5μS CRH : 6.25μS		CRL @ CH : 100μS CRL @ CL : 25μS CRH @ CL : 5μS		CRL @ CH : 100μS CRL @ CL : 25μS CRH @ CL : 2.5μS	
Accuracy	1k Ω : 4mS+0.2% 10k Ω : 1mS+0.1%		0.2% (setting + range)		0.2% (setting + range)	
Constant Voltage Mode						
Range	0~500V		0~300V		0~600V	
Resolution	20mV		6mV		12mV	
Accuracy	0.05% + 0.1%F.S.		0.05% + 0.1%F.S.		0.05% + 0.1%F.S.	
LED Mode						
Range	Operating Voltage: 0~100V/0~500V R _d Coefficient : 0.001~1 V _F : 0~100V/0~500V Current : 0~2A R _i : 1 Ω~1k Ω/10 Ω~10k Ω		Operating Voltage : 0~60V/0~300V R _d Coefficient : 0.001~1 V _F : 0~60V/0~300V LEDL @ CH : 0~60V- 0~20A (R _i : 0.05 Ω~50 Ω) LEDL @ CL : 0~60V- 0~5A (R _i : 0.8 Ω~800 Ω) LEDH @ CL : 0~300V- 0~5A (R _i : 4 Ω~4k Ω)		Operating Voltage : 0~60V/0~600V R _d Coefficient : 0.001~1 V _F : 0~60V/0~600V LEDL @ CH : 0~60V- 0~20A (R _i : 0.05 Ω~50 Ω) LEDL @ CL : 0~60V- 0~5A (R _i : 0.8 Ω~800 Ω) LEDH @ CL : 0~600V- 0~5A (R _i : 8 Ω~8k Ω)	
Resolution *2	V _o : 4mV/20mV I _o : 0.1mA R _d Coefficient : 0.001 R _d : 62.5μS/6.25μS V _F : 4mV/20mV		V _o : 1.2mV/6mV I _o : 100μA/400μA R _d Coefficient : 0.001 R _d : 400μS / 25μS / 5μS V _F : 1.2mV/ 6mV		V _o : 1.2mV/12mV I _o : 100μA/400μA R _d Coefficient : 0.001 R _d : 400μS/25μS/2.5μS V _F : 6mV/ 60mV	
Dynamic Mode						
Dynamic Mode	--		C.C. Mode		C.C. Mode	
T1 & T2	--		0.025ms ~ 50ms / Res: 5μs 0.1ms ~ 500ms / Res: 25μs 10ms ~ 50s / Res: 2.5ms		0.025ms ~ 50ms / Res: 5μs 0.1ms ~ 500ms / Res: 25μs 10ms ~ 50s / Res: 2.5ms	
Accuracy	--		1μs/1ms+100ppm		1μs/1ms+100ppm	
Slew Rate	--		0.8~200mA/μs		0.8~200mA/μs	
Resolution	--		0.8mA/μs		0.8mA/μs	
Accuracy	--		10% ± 20μs		10% ± 20μs	
Min. Rise Time	--		25μs (Typical)		25μs (Typical)	
Current	--		0~5A		0~5A	
Resolution	--		100μA		100μA	
Accuracy	--		0.4%F.S.		0.4%F.S.	
Measurement Section						
Voltage Read Back						
Range	0~100V	0~500V	0~60V	0~300V	0~60V	0~600V
Resolution	2mV	10mV	1.2mV	6mV	1.2mV	12mV
Accuracy	0.025%+0.025% F.S.		0.025%+0.025% F.S.		0.025%+0.025% F.S.	
Current Read Back						
Range	0~0.6A	0~2A	0~5A	0~20A	0~5A	0~20A
Resolution	12μA	40μA	100μA	400μA	100μA	400μA
Accuracy	0.05%+0.05% F.S.		0.05%+0.05% F.S.		0.05%+0.05% F.S.	

NOTE*1 : If the operating voltage exceeds 1.1 times of the rated voltage, it would cause permanent damage to the device.

NOTE*2 : S (siemens) is the SI unit of conductance, equal to one reciprocal ohm.



High Performance Hardware Devices and Software Architecture

LED Power Driver Automatic Test Systems

Model 8491

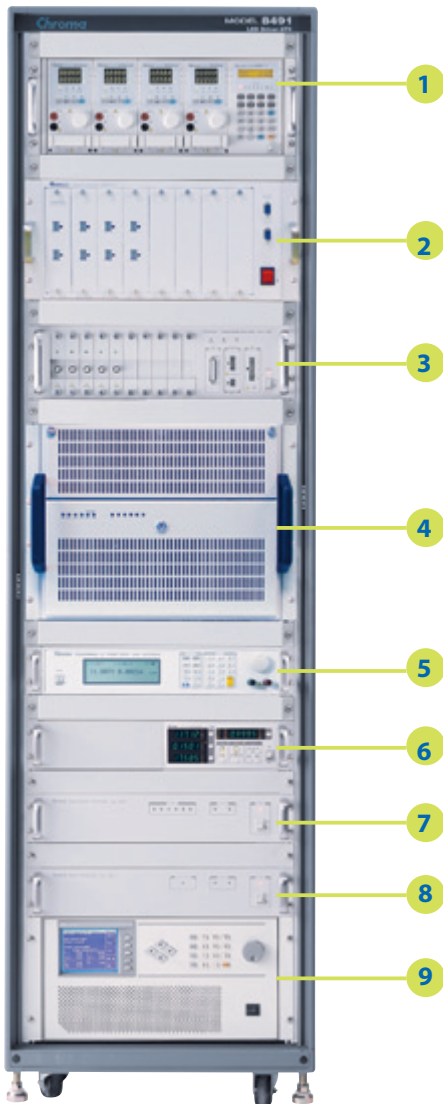

1. **DC Electronic Load** : Chroma 6310A/6330A Series
2. **Transducer Unit/Module***1 : Chroma A849101/A849102, A849103, A849104
3. **Time/Noise Analyzer** : Chroma 6011/80611 & 80611N card
4. **System Controller***2 : Industrial PC
5. **DC Source**: Chroma 62000P Series
6. **Digital Power Meter** : Chroma 66200 Series
7. **OVP/Short Circuit Tester** : Chroma 6012/80612
8. **ON/OFF Controller** : Chroma 6013/80613
9. **AC Source** : Chroma 6500/61500/61600 Series

*1 : A849101 transfers UUT output signal to voltage signal, and measure by 84911 LED power driver measurement card (200kHz). The optional 80611N Noise card is required for 20MHz ripple current measurement.
 *2 : The controller includes both 84911 LED Power Driver measurement card and 84903 control card.
 - **84911**: Measure rms current, dimming current/frequency/duty, timing, power & ripple current (200kHz)
 - **84903** : Provide BL control signal(DC level, PWM, SM bus), and enable ON/OFF signal.



The 8491 ATS hardware can be customized according to users (R/D, QC, Production Line) or according to different testing requirements. (Eg. lighting)

Optimized Test Items

The Chroma 8491 ATS is equipped with optimized standard test items for LED lighting driver testing. The user is only required to define the test conditions and specifications for the standard test items to perform the test.

The optimized test items cover 6 types of power supply test requirements. OUTPUT PERFORMANCES verify the output characteristics of the UUT. INPUT CHARACTERISTICS check the UUT input parameters. REGULATIONS test the stability of UUT under varying line-in and loading changes. TIMING & TRANSIENT test the timing and transient states during protection. PROTECTION TESTS trigger and test the protection circuit, the SPECIAL TESTS provide means to test the most sophisticated UUT when unique test routines are needed.

Output Performances

1. Output voltage
2. Output current
3. Ripple Current (RMS & p-p)
4. Dimming Current
5. Dimming Frequency
6. Dimming Duty
7. Efficiency
8. In-test adjustment
9. Turn on over shoot current

Input Characteristics

10. Input Inrush Current
11. Input RMS Current
12. Input Peak Current
13. Input Power
14. Current Harmonics
15. Input Power Factor
16. Input Voltage Ramp
17. Input Frequency Ramp
18. AC Cycle Drop Out
19. PLD Simulation

Regulation Tests

20. Current Regulation
21. Voltage Regulation
22. Total Regulation

Timing & Transient

23. Turn ON Time
24. Hold Up Time
25. Rise Time
26. Fall Time

Protection Tests

27. Short Circuit
28. OV Protection
29. OL Protection*
30. OP Protection*

Special Tests

31. GPIB Read/Write
32. RS232 Read/Write

* If UUT is constant voltage output

LED Lighting Driver Test Block Diagram

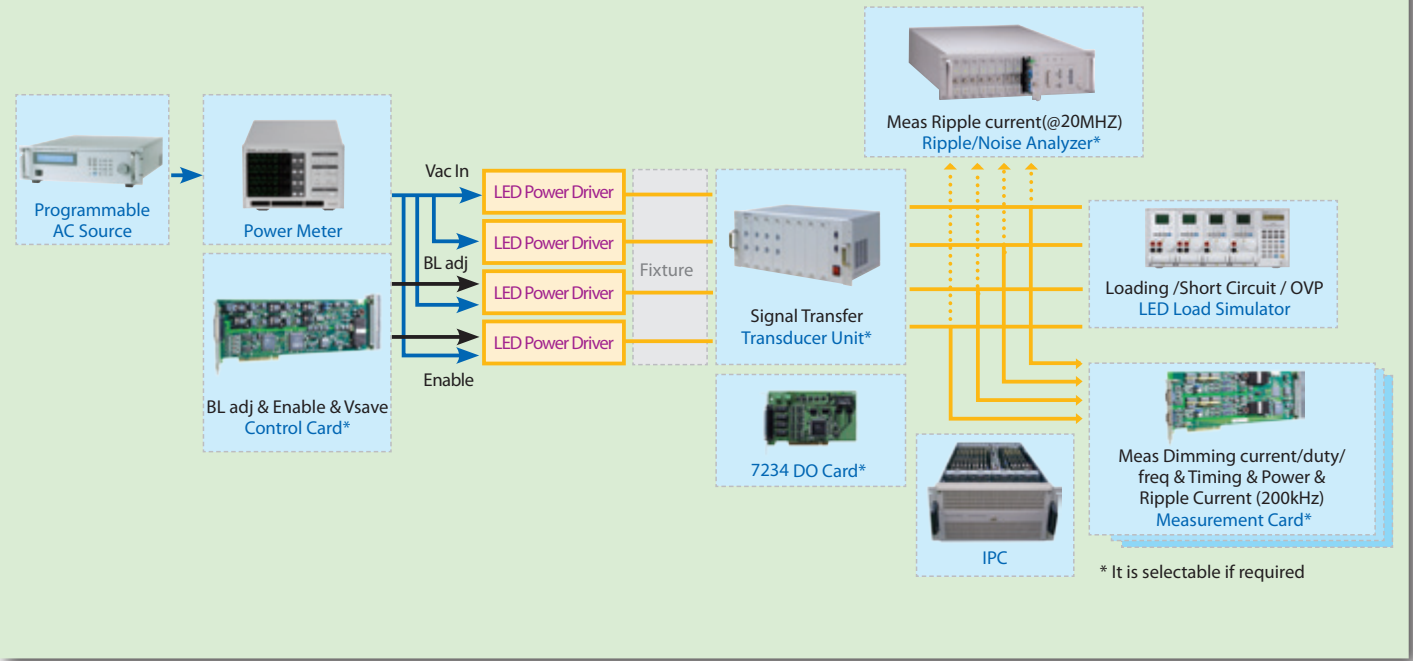

Software Platform of ATS

The Model 8491 Test System includes the industries most sophisticated power supply testing software platform, PowerPro III. PowerPro III provides users an open software architecture suited for a wide range of applications and devices. PowerPro III runs under the user friendly Windows 98/2000/NT/XP operating environment, which provides engineers a dedicated LED Power Driver test system with easy access to Windows resources.

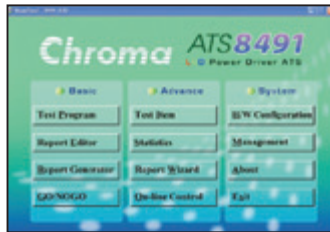

Software Main Screen

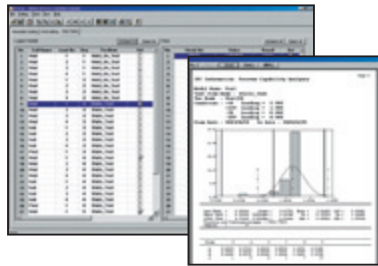

Statistical Report

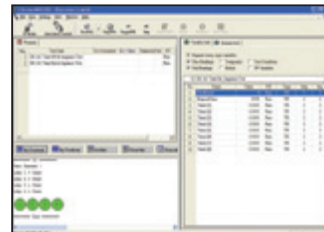

Running GO/NOGO

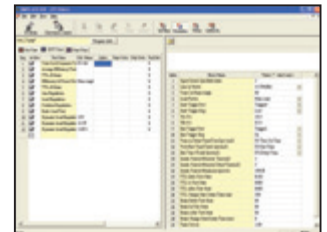

Test Program Editing

Transducer Module		A849102	A849103	A849104
Input				
Vrms	Range	0~80V / 0~500V	0~80V / 0~500V	0~80V / 0~500V
	Bandwidth	200 KHz @ -3dB	200KHz @ -3dB	200KHz @ -3dB
	Accuracy	0.3%+0.2%F.S.	0.3%+0.2%F.S.	0.3%+0.2%F.S.
Irms	Range	0~100mA 0~200mA 0~400mA	0~400mA 0~800mA 0~1600mA	0~5A 0~10A 0~20A
	Bandwidth	200KHz @ -3dB	200KHz @ -3dB	200KHz @ -3dB
	Accuracy	0.5%+0.5%F.S.	0.5%+0.5%F.S.	0.5%+0.5%F.S.
Ripple Current (rms & p-p)	Range	0~50mAp-p 0~100mAp-p 0~150mAp-p	0~100mAp-p 0~400mAp-p 0~800mAp-p	0~1.25Ap-p 0~5Ap-p 0~10Ap-p
	Bandwidth	20MHz @ -3dB	20MHz @ -3dB	20MHz @ -3dB
	Accuracy	0.5%+0.5%F.S.	0.5%+0.5%F.S.	0.5%+30mA@5A 0.5%+60mA@10A/20A
Voltage Ripple/Noise (rms & p-p)	Range	2.5Vp-p / 20Vp-p	2.5Vp-p / 20Vp-p	2.5Vp-p / 20Vp-p
	Bandwidth	20MHz @ -3dB	20MHz @ -3dB	20MHz @ -3dB
	Accuracy	1% F.S.	1% F.S.	1% F.S.
-3dB Tolerance		± 1dB	± 1dB	± 1dB
Output				
9 Pin D-sub (to 84911 M card)	Range	4Vpk	4Vpk	4Vpk
BNC (to 80611N card)	Range	2Vp-p	2Vp-p	2Vp-p





**HEADQUARTERS
CHROMA ATE INC.**

66 Huaya 1st Road, Guishan, Taoyuan 33383, Taiwan
T +886-3-327-9999
F +886-3-327-8898
info@chromaate.com
www.chromaate.com

**CHINA
CHROMA ELECTRONICS (SHENZHEN) CO., LTD.**

8F, No.4, Nanyou Tian An Industrial Estate,
Shenzhen, China PC: 518052
T +86-755-2664-4598
F +86-755-2641-9620
www.chroma.com.cn

**JAPAN
CHROMA JAPAN CORP.**

472 Nippa-cho, Kouhoku-ku, Yokohama-shi,
Kanagawa, 223-0057 Japan
T +81-45-542-1118
F +81-45-542-1080
info@chroma.co.jp
www.chroma.co.jp

**U.S.A.
CHROMA SYSTEMS SOLUTIONS, INC.**

19772 Pauling, Foothill Ranch, CA 92610
T +1-949-600-6400
F +1-949-600-6401
sales@chromausa.com
www.chromausa.com

**U.S.A.
CHROMA ATE INC. (U.S.A.)**

7 Chrysler Irvine, CA 92618
T +1-949-421-0355
F +1-949-421-0353
Toll Free +1-800-478-2026
info@chromaus.com
www.chromaus.com

**EUROPE
CHROMA ATE EUROPE B.V.**

Morsestraat 32, 6716 AH Ede, The Netherlands
T +31-318-648282
F +31-318-648288
sales@chromaeu.com
www.chromaeu.com